

PC160 Control Box

24 VDC GEAR MOTOR

FOR RESIDENTIAL
USER MANUAL

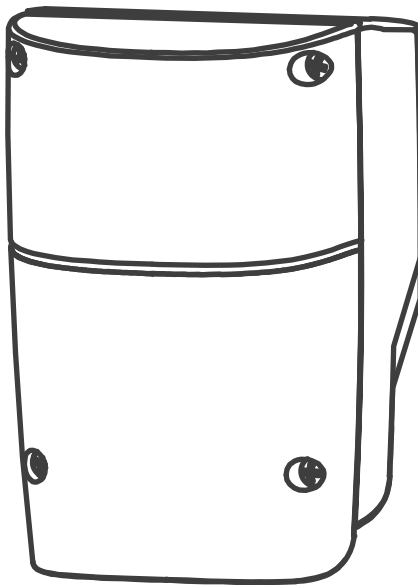

Index

1.	PC160 Control Box	2
2.	Setting	4
2.1	SW1 Dip Switch Setting	4
2.2	Functional Switch and LED lights Introduction	5
2.3	Transmitter Memorizing and Erasing Process	5
2.4	System Learning Process	5
2.5	Gate Operation	6
2.6	Gate-moving Logic	6
3.	Trouble Shooting	6

1). PC160 Control Box

1. Decide the installation position of PC160 control box first, it is suggested to be installed near the gate and should be protected from possible damage. Be aware of the motor cable length before deciding the installation position.
2. Remove the cover by unscrewing the four screws on the cover. See **Figure 1(1)**.
3. Use a screwdriver to puncture the holes beneath the bottom of the control box. See **Figure 1(2)**.
4. Secure it on the wall. See **Figure 1(3)**.

Figure 1(1)

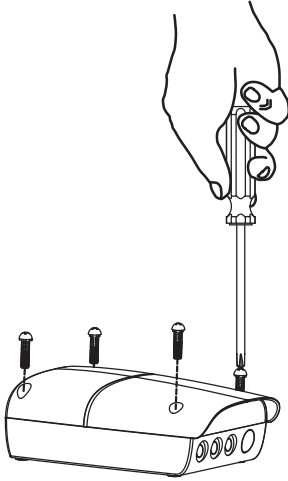

Figure 1(2)

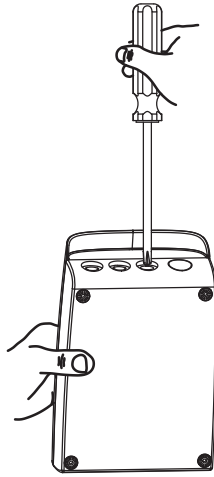
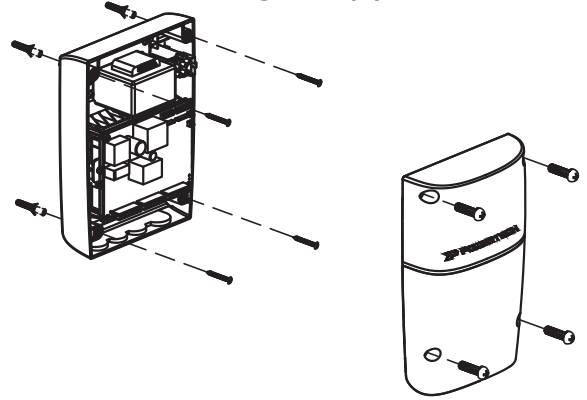

Figure 1(3)



5. Wiring Connection:

Prepare all the wires of the accessories beforehand and connect the wires to the gear motors and accessories on the PCB as shown in **Figure 1(4)**. All of the wiring connections of the accessories are not requested to distinguish the positive (+) and the negative (-) polarity.

- 1). PF-1 Flashing light: Connect the two wires from the flashing light to the terminal LIGHT and GND on the PCB.
- 2). PEL-1 Electric Latch: Connect the two wires from the electric latch to the terminal LATCH and GND on the PCB.
- 3). PW150/PW200 Gear Motors:

Refer to **Figure 1(5)** and connect the wires separately to the terminals on the PCB.

M1: Connect the motor wire (White +) to the terminals M1 (+), and (Yellow -) to the M1 (-).

M2: Connect the motor wire (White +) to the terminals M2 (+), and (Yellow -) to the M2 (-).

Notes:

For gates opened outward,

M1: Connect the motor wire (Yellow -) to the terminals M1 (+), and (White +) to the terminals M1 (-).

M2: Connect the motor wire (Yellow -) to the terminals M2 (+), and (White +) to the terminals M2 (-).

- 4). PH-1 Photocells: Please remove the cover of JP1 and connect the wires to proper terminals.

5). PKS-1 Key Selector:

For Single leaf operation-Refer to **Figure 1(4)** and connect the two wires from the key selector to the terminal BUTT1 and GND (J7) on the PCB.

For Dual leaf operation-Refer to **Figure 1(4)** and connect the two wires from the key selector to the terminal BUTT2 and GND (J7) on the PCB.

6). PPB-1 Push Button:

For Single leaf operation-Refer to **Figure 1(4)** and connect the two wires from the key selector to the terminal BUTT1 and GND (J7) on the PCB.

For Dual leaf operation-Refer to **Figure 1(4)** and connect the two wires from the key selector to the terminal BUTT2 and GND (J7) on the PCB.

- 7). JP2 Jumper Socket: If there is any external device connecting to stop/GND/close/open terminals on the PCBA, please remove JP2 cover to make the device effective.

Figure 1(4)
PW150/200 Manual

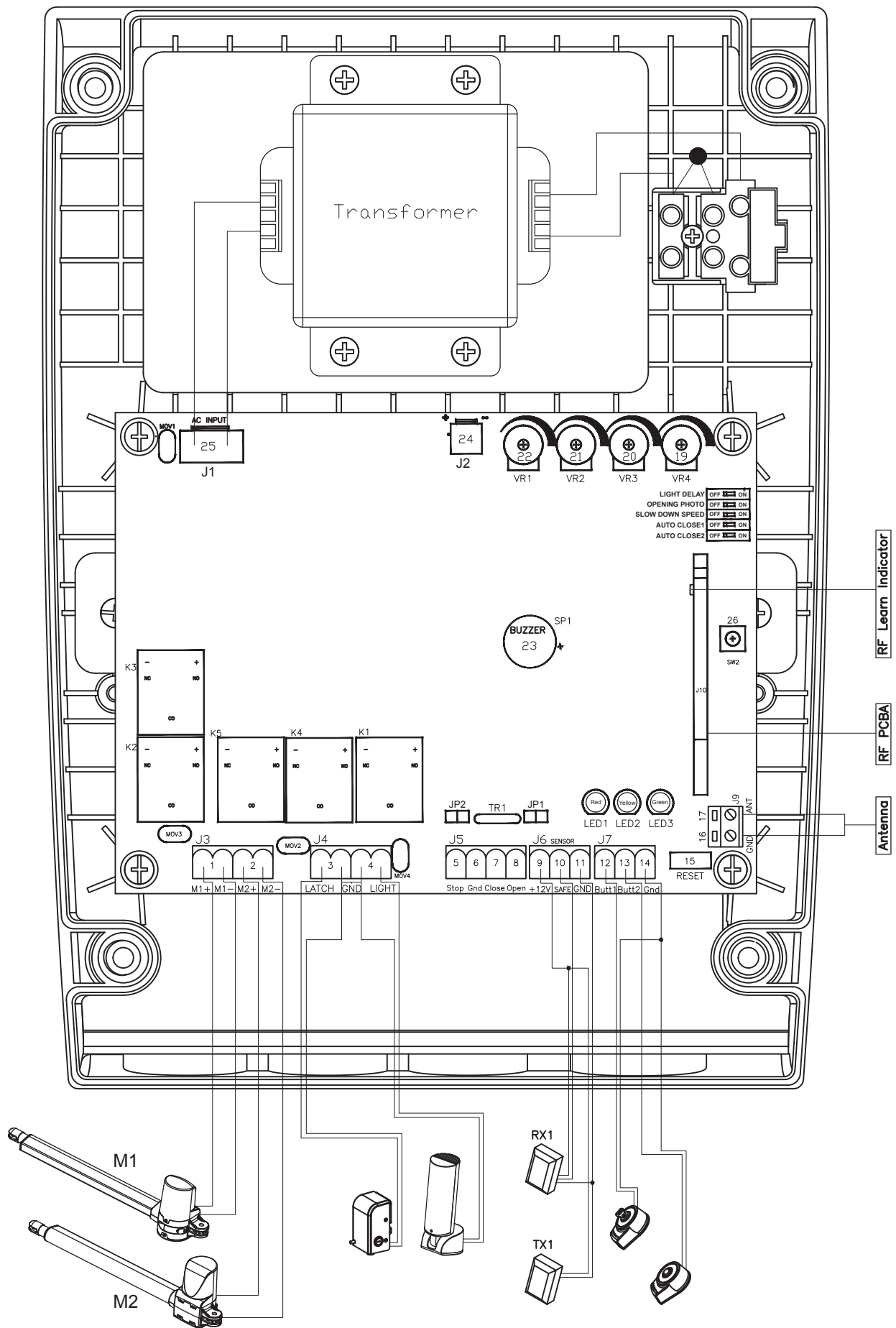
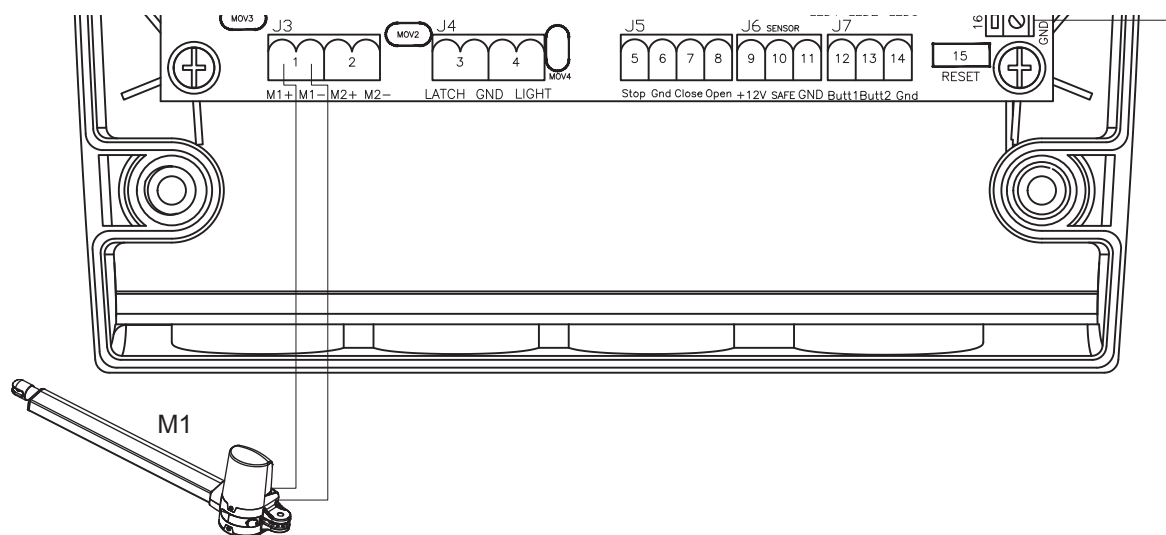
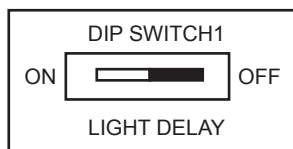

Figure 1(5)



2). Setting

2.1 SW1 Dip Switch Setting



LIGHT DELAY: (Factory Default: OFF)

ON: The flashing light blinks for 5 seconds before the gate moves.
OFF: The flashing light blinks and the gate moves simultaneously.

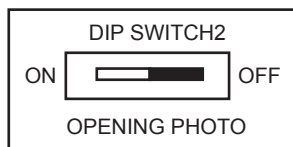

OPENING PHOTO: (Factory Default: OFF)

ON: In the opening phase, the gate will stop when the photo sensor is activated.
 In the closing phase, the gate will stop and open to the end when the photo sensor is activated.

OFF: In the opening phase, the gate will not stop when the photo sensor is activated.
 In the closing phase, the gate will stop and open to the end when the photo sensor is activated.

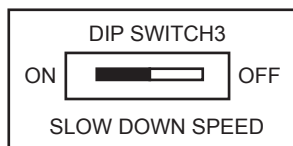

SLOW DOWN SPEED: (Factory Default: ON)

The final speed can be set when the gate is moving at slow-down speed.
ON: The final speed = 55% normal speed.
OFF: The final speed = 70% normal speed.

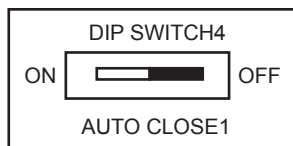

AUTO CLOSE1: (Factory Default: OFF)

The function of auto close or without auto close can be selected.

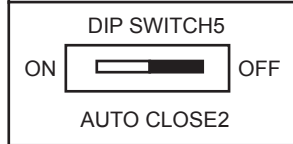

AUTO CLOSE2: (Factory Default: OFF)

The function of auto close or without auto close can be selected.

DIP4 (Auto close1)	DIP5 (Auto close2)	Function
OFF	OFF	Without auto close function
OFF	ON	Auto close On, waiting time 50 seconds
ON	OFF	Auto close On, waiting time 25 seconds
ON	ON	Auto close On, waiting time 12 seconds

NC: No Connection

2.2 Functional Switch and LED lights Introduction

SW2	The button of transmitter memorizing and erasing.
VR1	Close delay of two leaves can be adjusted from min 0 second to Max. 7 second.
VR2	The over-current sensitivity of Master Gate (M1) could be adjusted from 1.8 second to 3.8 second.
VR3	The over-current sensitivity of Master Gate (M2) could be adjusted from 1.8 second to 3.8 second.
VR4	Over-current limit can be adjusted from min 0.8Amp to Max 4.2 Amp.
LED1 (Red)	LED1 is ON when AC input is in. And LED1 blinks quickly when the gate is in slow-down speed.
LED2 (Yellow)	When the photocells are triggered, LED2 will be on.
LED3 (Green)	When the transmitter/push button/key selector is triggered, LED3 will be on.

Notes:

1. VR1,VR2,VR3 will be adjusted to 10 o'clock direction as the factory default.
2. VR4 will be adjusted to 2 o'clock direction as the factory default.

2.3 Transmitter Memorizing and Erasing Process

RF Transmitter Memorizing & Erasing

2.3.1 Press button SW2 for 1 second, the blue LED light on the receiver board will be on and receiver module will be changed to "Learning Mode" for 10 seconds. During the period of learning mode, press the left button on the transmitter, then the transmitter can be memorized by receiver module. (Up to 200 different transmitter can be memorized) The blue light on the receiver board will blink twice after pressing the button on the transmitter. The blue light on the receiver board will go off when the transmitter memorizing is done.

2.3.2 The memory can be cleared completely if the SW2 (code learning) is pressed continuously for 10 seconds after the blue light.

Self-Learning mode for gate operation systems

Step1:	Connect the wires of two motors with terminal M1+/M1- & M2+/M2-
Step2:	Connect 230VAC with terminal J1 and battery with J2.
Step3:	In single leaf installation, just connect the motor wires with terminal M1+/M1-
Step4:	Press SW2 button for more than 1 second and the blue light on the receiver board is on. Press the left button on the transmitter to memorize the transmitter with the receiver board. The blue light will be off after the transmitter memorizing is done.
Step5:	In Single or Dual leaf installation, please press the left button of the remote control for system learning. After pressing the left button, system learning will be executed step by step as follows: 1. Dual Gate: Slave Gate Close → Master Gate Close → Master Gate Open → Slave Gate Open → Slave Gate Close → Master Gate Close 2. Single Mode : Master Gate Close → Master Gate Open → Master Gate Close
Step 6:	If motor stops during the learning mode, please adjust the over current switch to proper position.

2.4 System Learning Process

Connect the master motor wires to M1 terminals and the slave motor wires to M2 terminals correctly. If only one gate is installed, the motor wires have to be connected to M1 terminals.

In system learning mode, the gates will proceed with the following procedures.

- (A) Dual-Gate Mode: Slave Gate closes→ Master Gate closes→ Master Gate opens →Slave Gate opens → Slave Gate closes→ Master Gate closes.
(B) Single-Gate Mode: Master Gate closes→ Master Gate opens→ Master Gate closes.

Notes: System learning fails and needs to be learned again when an unpredictable interruption occurs.

2.5 Gate Operation

In dual gate installation:

Press the button "A" on the transmitter for dual-gate operation.

Press the button "B" on the transmitter for single-gate operation.

In single gate installation:

Press the button "A" on the transmitter for single-gate operation.

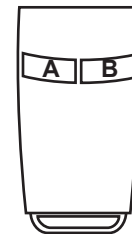

PR-1

2.6 Gate-moving Logic

(A) In gate-opening phase: The gates stop if the transmitter/push button/key selector is activated, and close when the transmitter/push button/key selector is reactivated.

(B) In gate-closing phase: The gates stop if the transmitter/push button/key selector is activated, and open when the transmitter/push button/key selector is reactivated.

(C) In gate-opening or gate-closing phase: For safety purpose, the gates stop if encountering obstacles.

3. Trouble Shooting

Symptoms	Recommended checks and possible solution
Overheated Back-up Batteries	Check the wiring connection of the batteries.
The gate doesn't move when pressing the button of the transmitter	<ol style="list-style-type: none"> 1. Check if the voltage of the batteries is below 21V. 2. Check if LED1 is "ON". 3. Make sure all the wiring connections are firmly connected to the terminals on the PCB. 4. Make sure the fuse is workable.
The Flashing light does not work	<ol style="list-style-type: none"> 1. Check if the wiring connection of the flashing light is correct. 2. Check if the bulb is burned.
The leaves shall be closed instead of opening	Change the polarity connection of the positive (+) with the negative (-) of the gear motors.
The leaves does not move or only move toward one direction	<ol style="list-style-type: none"> 1. Check if the "RESET" socket is activated. 2. Make sure the wiring connection of the gear motors is firm. 3. The GND terminal of the photocells on the PCB must be short-circuited if no photocells installed.
The master gate closes to the end first and the slave gate stops, the flashing light blinks fast for five seconds.	Cut off the AC input power and the output of the batteries. Release the master gate and slave gate manually, then open the master to the end and close the slave gate to the end by hand, then power the whole unit by connecting the AC and battery terminals.
The gear motors does not run and the relay is noisy when operating the gate opening and closing.	Check if the fuse is burned.



1095 Budapest, Mester utca 34. **1141 Budapest, Fogarasi út 77.**
 Tel.: *218-5542, 215-9771, 215-7550, Tel.: *220-7940, 220-7814, 220-7959,
 216-7017, 216-7018 Fax: 218-5542 220-8881, 364-3428 Fax: 220-7940
 Mobil: 30 940-1970, 30 959-0930 Mobil: 30 531-5454, 30 939-9989

E-mail: delton@delton.hu Web: www.delton.hu

www.kaputnyitunk.hu